

Varenummer: 2310431061S
Beskrivelse: E+G Stilleben
LX.30-SW17-M8X33-S

Mål

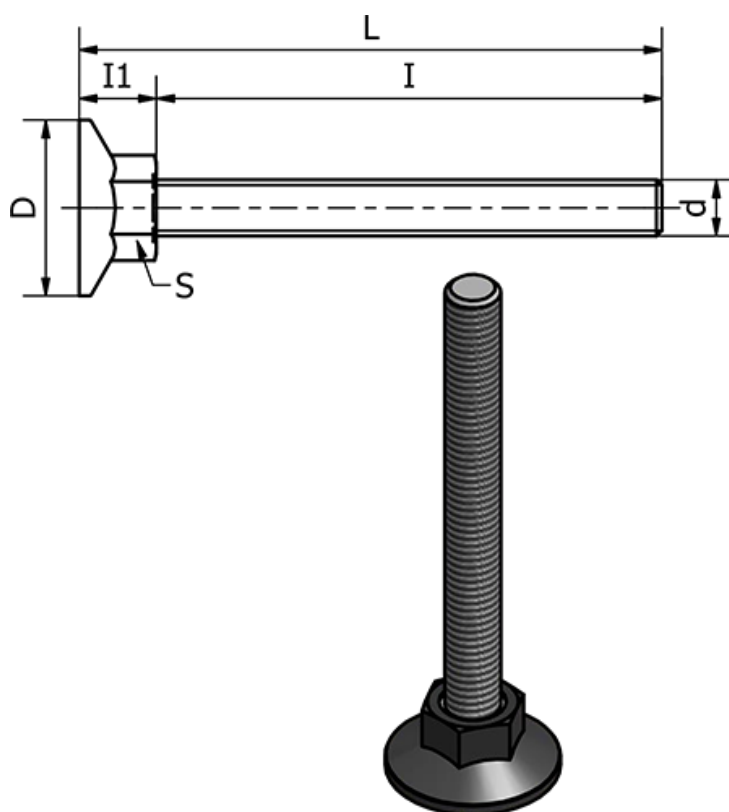

| | |
|----------------------------|-------------|
| d | = M8 |
| D | = 30 |
| I | = 33 |
| I1 | = 12 |
| L | = 45 |
| Max statisk belastning (N) | = 2500 |
| S | = 17 |
| Type | = Forzinket |

Vægt (g) = -